

Heterogeneous ABAP System Copy – Technical Overview

Boris Zarske – SAP Product Management
December 2015

Public

The SAP logo is located in the bottom left corner of the slide. It consists of the letters 'SAP' in a bold, white, sans-serif font, set against a blue square background with a white diagonal line.

Goal of this presentation

Even if heterogeneous system copies must only be performed by certified system support consultants or certified SAP Technical Consultants, the intention of this presentation is to provide a technical overview for all involved in **heterogeneous copy/migration projects of ABAP systems**

- Standard process flow (not all variations are covered)
- Involved tools
- Most important files that were created

This presentation is not intended to replace any training on OS and DB migration, such as *TADM70 SAP System: Operating System and Database Migration*

Agenda

Overview of System Copy of SAP Systems

Technical Overview of Heterogeneous ABAP System Copy

- Standard process Flow
- Involved Tools
- Created Files

Further Information

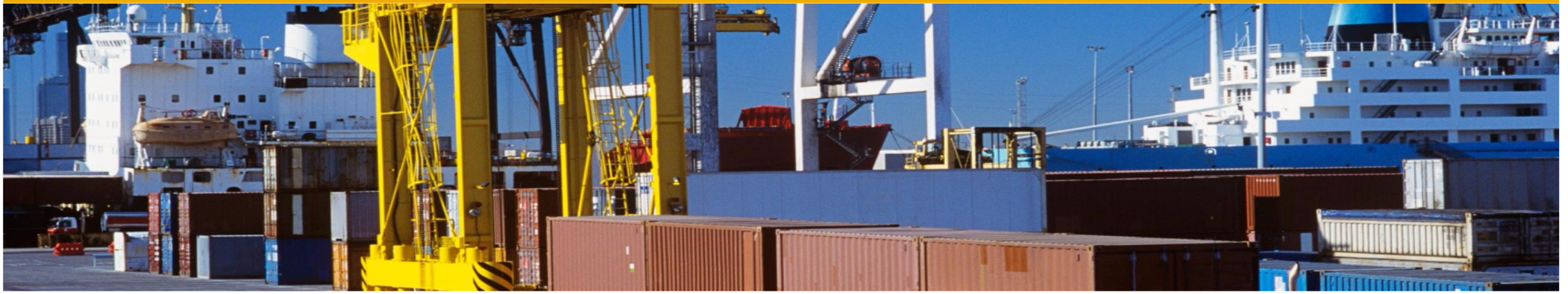

SAP System Copy

Overview



SAP System Copy

Introduction

If you want to duplicate an SAP system, you perform a system copy

- Certain SAP parameters may change when a system is copied
- As part of system copy, all instances are newly installed, but database is set up using a copy of source system database

A system copy can be either homogeneous or heterogeneous:

- *Homogenous System Copy*
 - Both operating system and database system stay the same
 - Performed in most cases with database-specific procedure (database-independent procedure could optionally also be used)
- *Heterogeneous System Copy*
 - One of the following is changed during the system copy:
 - Operating system (in this case, system copy is called *OS migration*)
 - Database system (in this case, system copy is called *DB migration*)
 - Operating system and database system (in this case, system copy is called *OS/DB migration*)
 - Has to be performed with database-independent procedure (with some exceptions for certain OS migrations, where cross-platform backup-/restore is supported)

SAP System Copy

Introduction – use cases

System copies are elemental part of lifecycle of SAP landscapes:

- Create test, demo and training systems as **copy** of existing systems

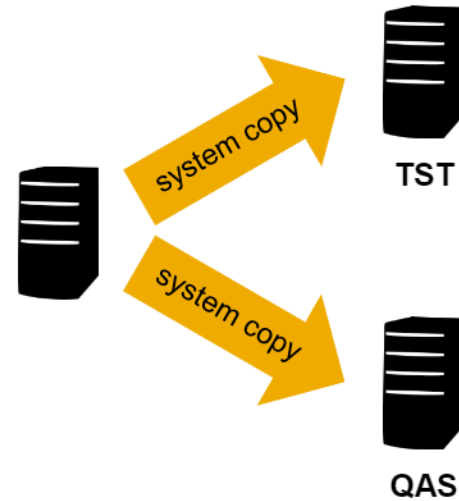

- Change your operating system and/or database by **migrating** your system

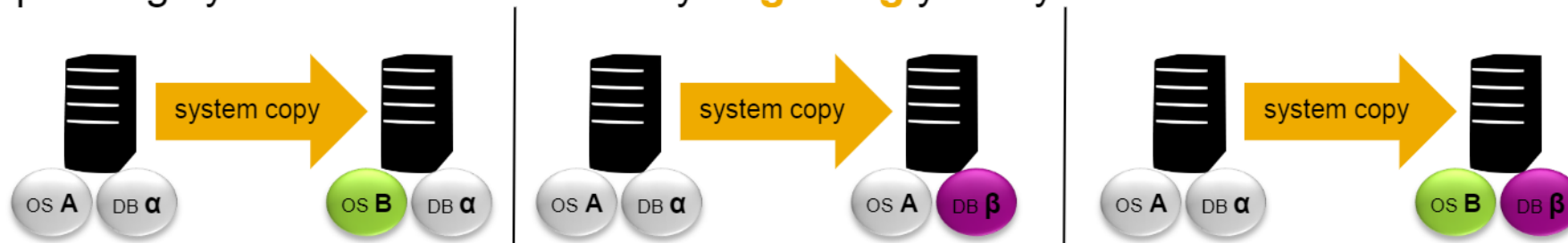

- Perform a **Unicode conversion**

SAP System Copy

Introduction – use cases

NOTE:

If you want to change characteristics of an existing SAP system, you can now use the **system rename** procedure for many product versions instead of performing a system copy

- Changes hostname, instance number or system ID (SAP system ID or database system ID)
- No system copy required
- For more information, see the corresponding [SCN page](#) and [SAP Note 1619720](#)

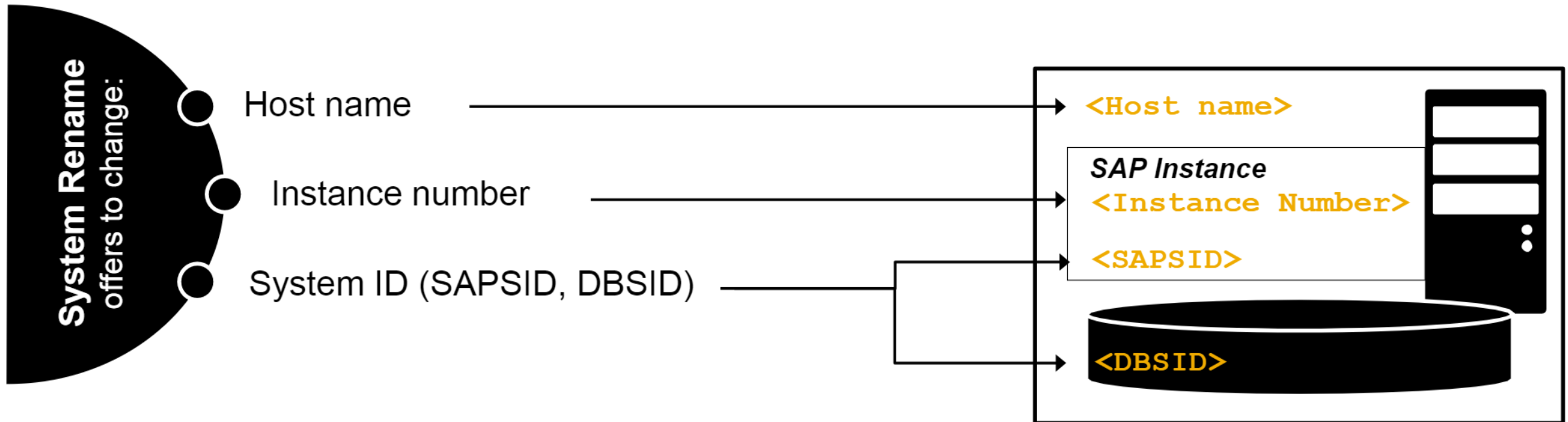

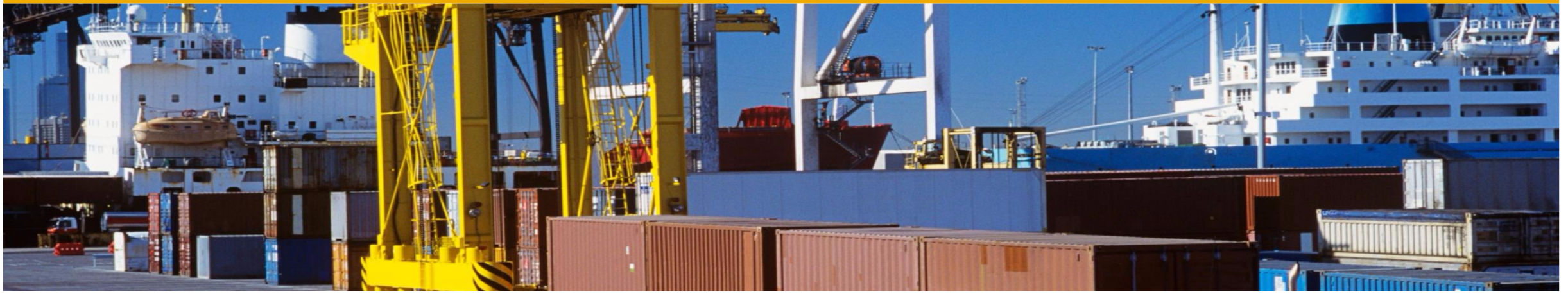

Heterogeneous ABAP System Copy

Tools involved in standard migration process (including most important created files)

Migration of ABAP Systems

Involved tools

Software Provisioning Manager

- Provides latest version of SAPinst
- *Key objective*: installs SAP systems, controls the system copy (overall orchestration of involved tools)
- Available via *Software Logistics Toolset*



Migration Monitor (MIGMON)

- *Key objective*: control load, accelerate load by automatic parallelization
- Triggers creation of R3load task (`TSK`) files (generated by R3load) and generates command (`CMD`) files
- Part of *software provisioning manager*



R3load

- *Key objective*: performs all load tasks in database- and platform-independent format
- Generates database export of all SAP objects that are defined in the ABAP Dictionary in database-independent format, including configuration and components in the file system
- Performs load of ABAP tables into target database
- Available via kernel of SAP application server ABAP



Migration of ABAP Systems

Involved tools

R3LDCTL

- *Key objective*: make information of source system database tables available for migration tools offline
- Reads ABAP Dictionary structures from source database
- Creates structure (`STR`) files that describe definition of tables, indexes and views
- Creates database-specific template (`TPL`) files that contain Data Definition Language (`DDL`) commands that define data structures
- Available via kernel of SAP application server ABAP



R3SZCHK

- *Key objective*: calculate size of target database
- Calculates space requirements of ABAP tables and indexes for target database (stored in `EXT` files) and rough estimation of overall database size (`DBSIZE.XML`)
- Available via kernel of SAP application server ABAP



R3ta Table Splitter

- *Key objective*: accelerate load by preparing parallel load (optional)
- Can generate multiple `WHERE` conditions that define work packages (stored in `WHR` files) for parallel R3load processes
- Available via kernel of SAP application server ABAP



Migration of ABAP Systems

Involved tools

Package Splitter

- *Key objective*: splits default packages into smaller parts to reduce overall runtime of export + import
- Splits packages using existing structure files (`STR` + `EXT`)
- Default, but can be skipped for small databases
- Part of *software provisioning manager*



MIGCHECK

- *Key objective*: make sure import was successful
- Verified that the import of all packages was at least started and that all objects (tables, views, indexes, primary keys) are successfully created/loaded in the database
- Optionally, you can perform further checks (such as using [Table Checker](#) to verify if number of exported rows is same as number of imported rows)
- Part of *software provisioning manager*



MIGTIME (Time Analyzer)

- *Key objective*: provide statistics about run-times of load processes (calculates run-time per package)
- Part of *software provisioning manager*



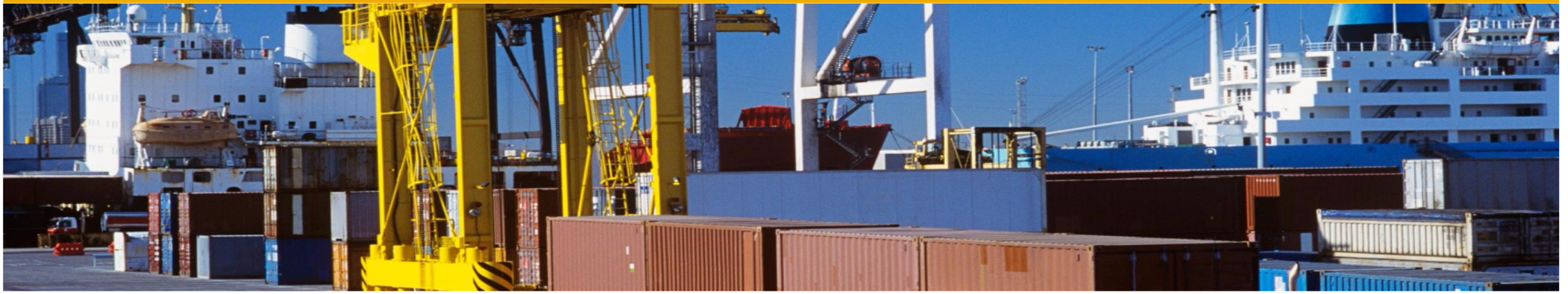

Heterogeneous ABAP System Copy

Plan & prepare

Migration of ABAP Systems

Plan

Plan your migration process – for example:

- Consider downtime of source system
- Perform test run of system copy
 - Calculate expected downtimes based on experience made during test run
 - Adapt general process to actual system and environment
- Plan to order and install new SAP license for target system

For more information, see system copy documentation

Migration of ABAP Systems

Prepare

Prepare the migration – for example:

- Check that SAP kernel delivered with installation kit fits to SP level of source system
- Prepare source system (for example, check for canceled or pending update requests and operation mode)
- For migration to SAP HANA, check source database (for example, for tables with high data volume and to verify transformation of cluster and pool tables performed during migration will work properly)
- **Download latest tool versions:**
 - Always use latest version of **Software Provisioning Manager** in SAP Service Marketplace at: <http://service.sap.com/sltoolset>
 - Download latest update of **R3* tools** versions from SAP Service Marketplace at: <http://support.sap.com/swdc>
→ *Support Packages and Patches* → *A – Z Alphabetical List of Products* → *K* → *SAP KERNEL <VERSION>*
→ *<Release>* → *<Platform>*
 - Download latest SAPCAR version from SAP Service Marketplace at: <http://support.sap.com/swdc>
→ *Support Packages and Patches* → *A – Z Alphabetical List of Products* → *S* → *SAPCAR*
- Make installation media available (such as kernel DVD)
- Generate a [migration key](#)

For more information, see system copy documentation

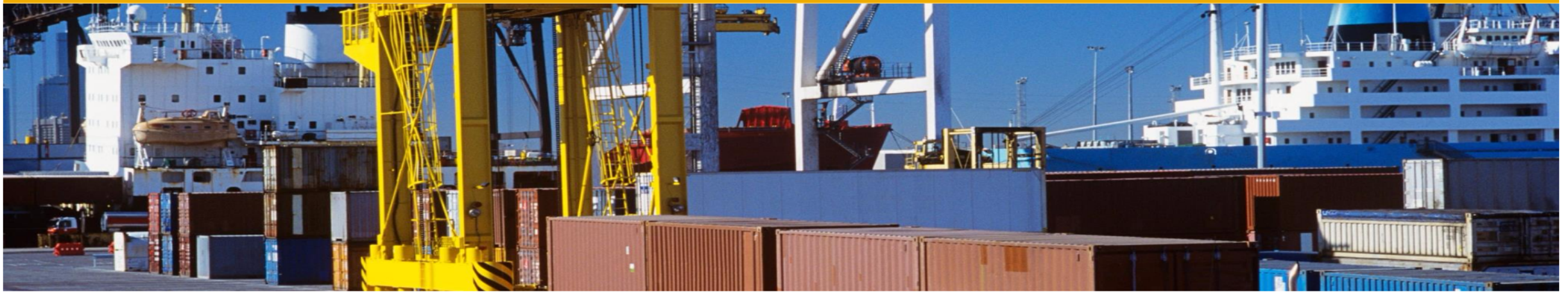

Heterogeneous ABAP System Copy

Standard process flow of export

Migration of ABAP Systems

Process flow of export



Migration of ABAP Systems

Process flow of export

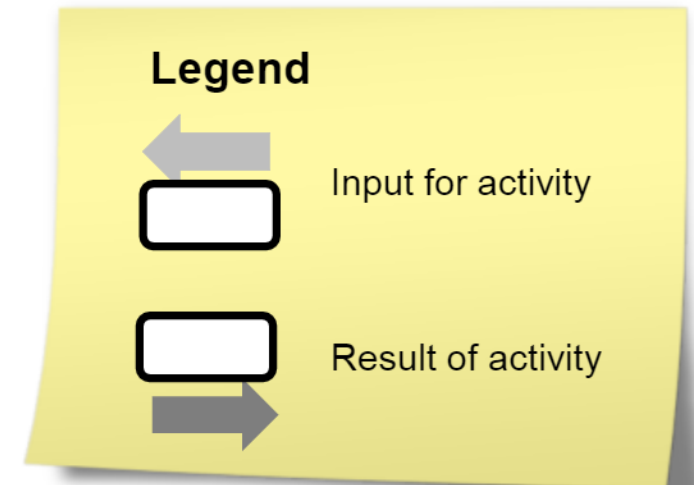
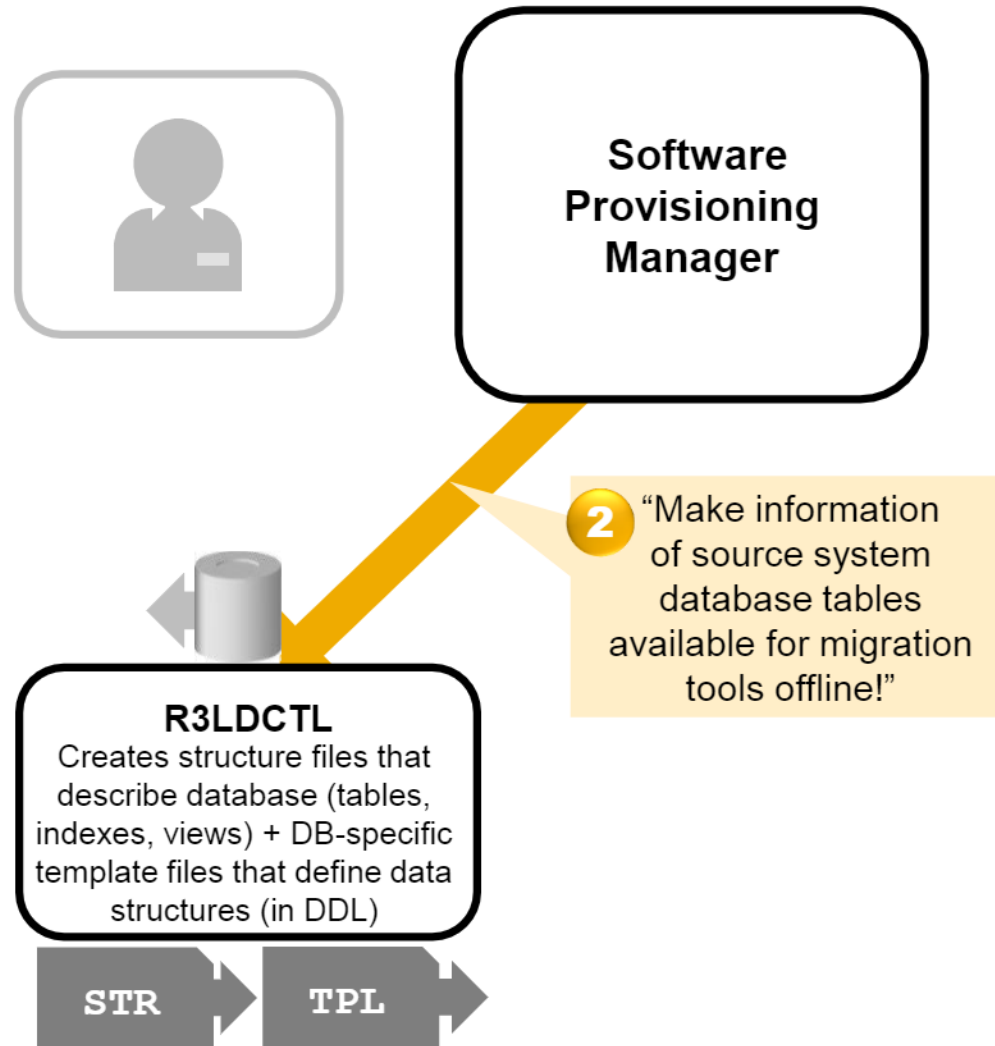

Migration of ABAP Systems

Process flow of export

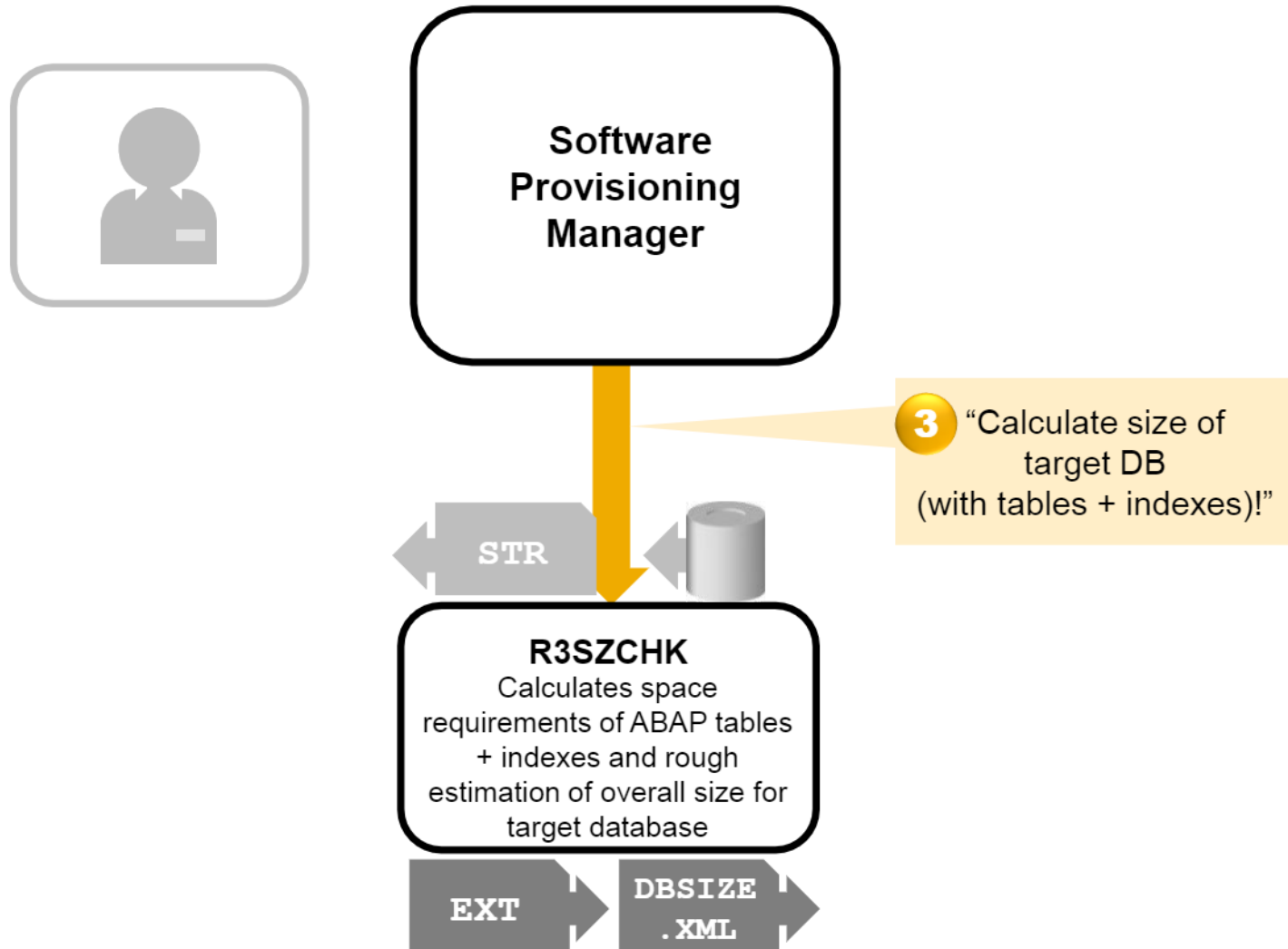

Migration of ABAP Systems

Process flow of export

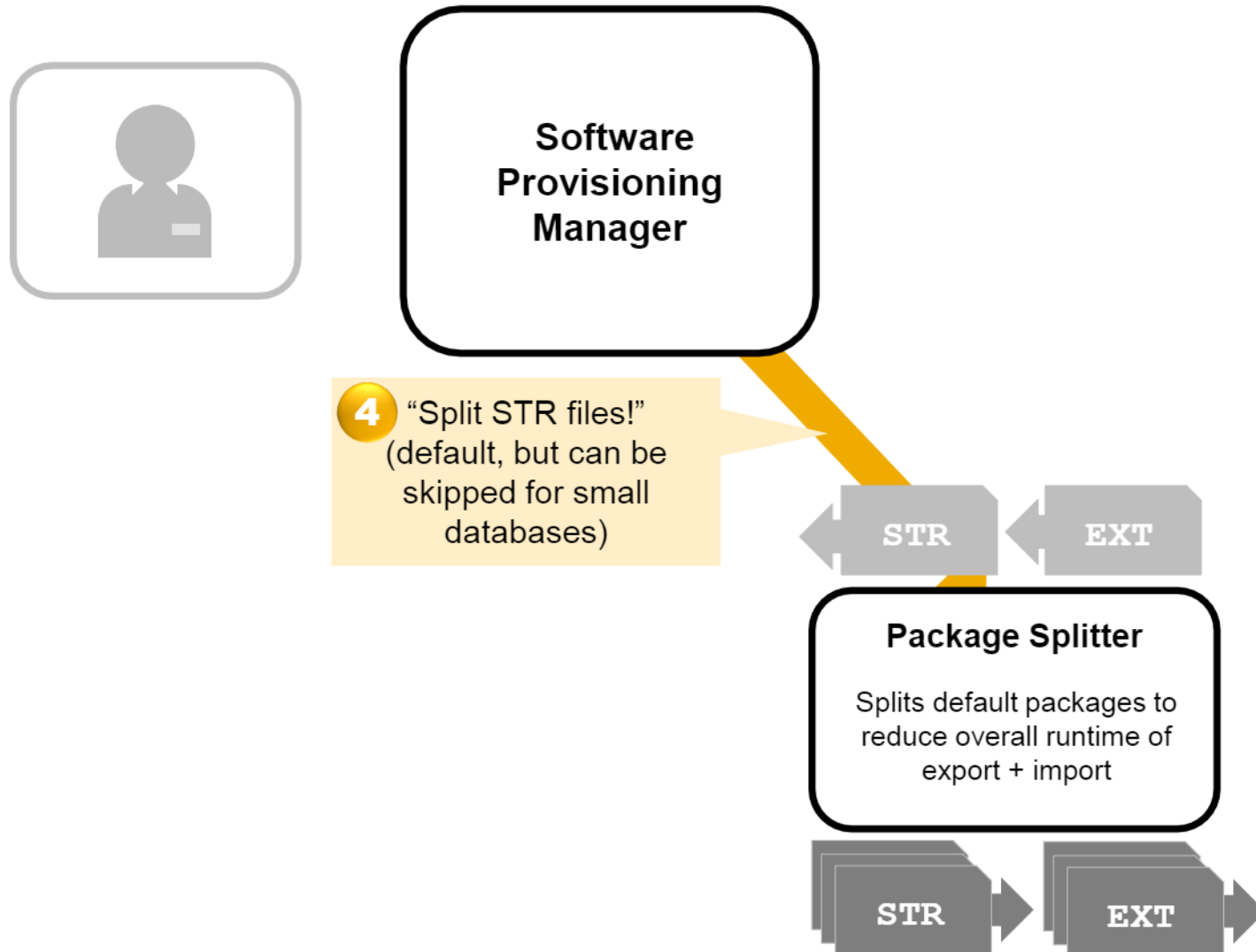

Migration of ABAP Systems

Process flow of export

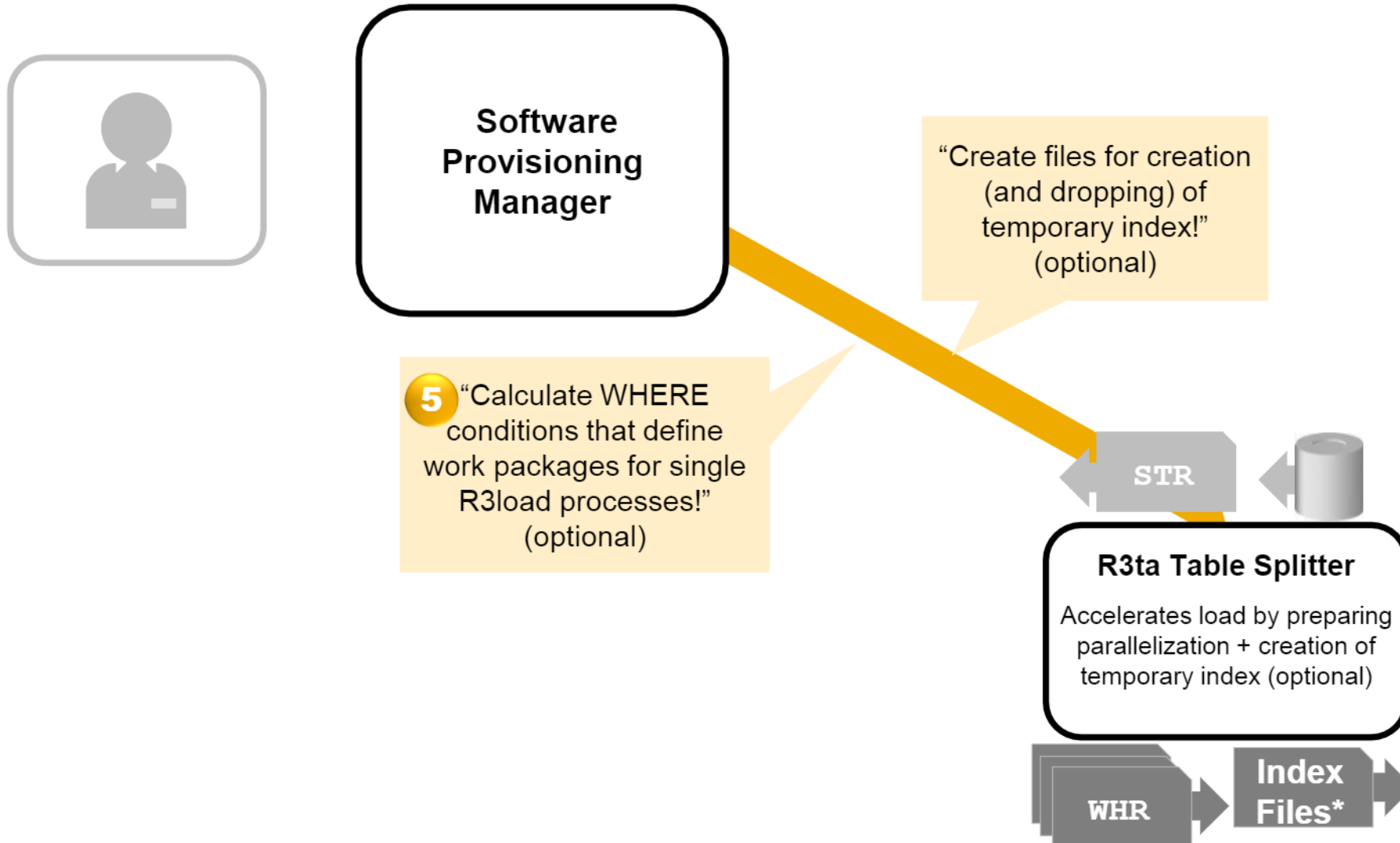

Migration of ABAP Systems

Process flow of export

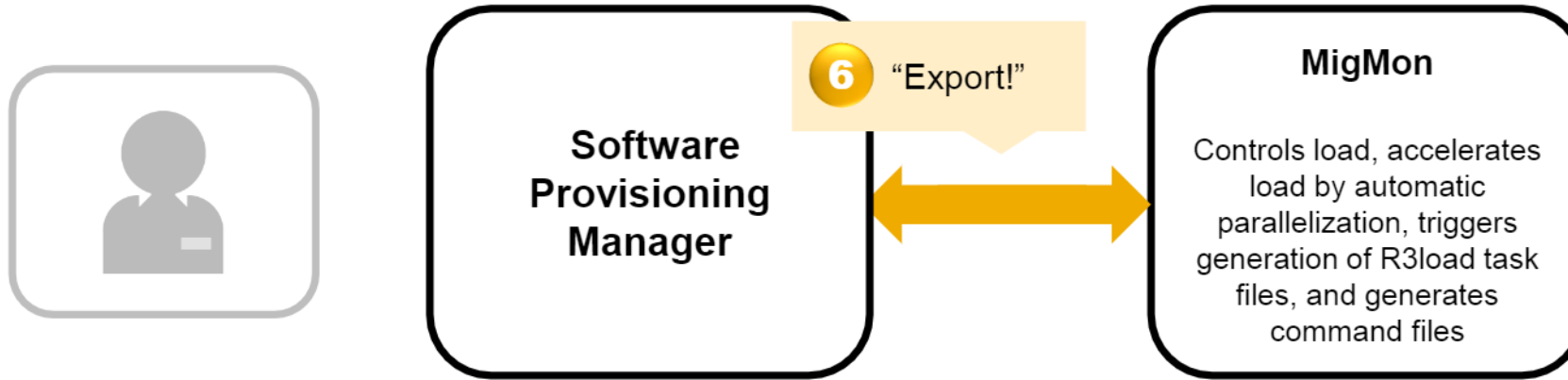

Migration of ABAP Systems

Process flow of export

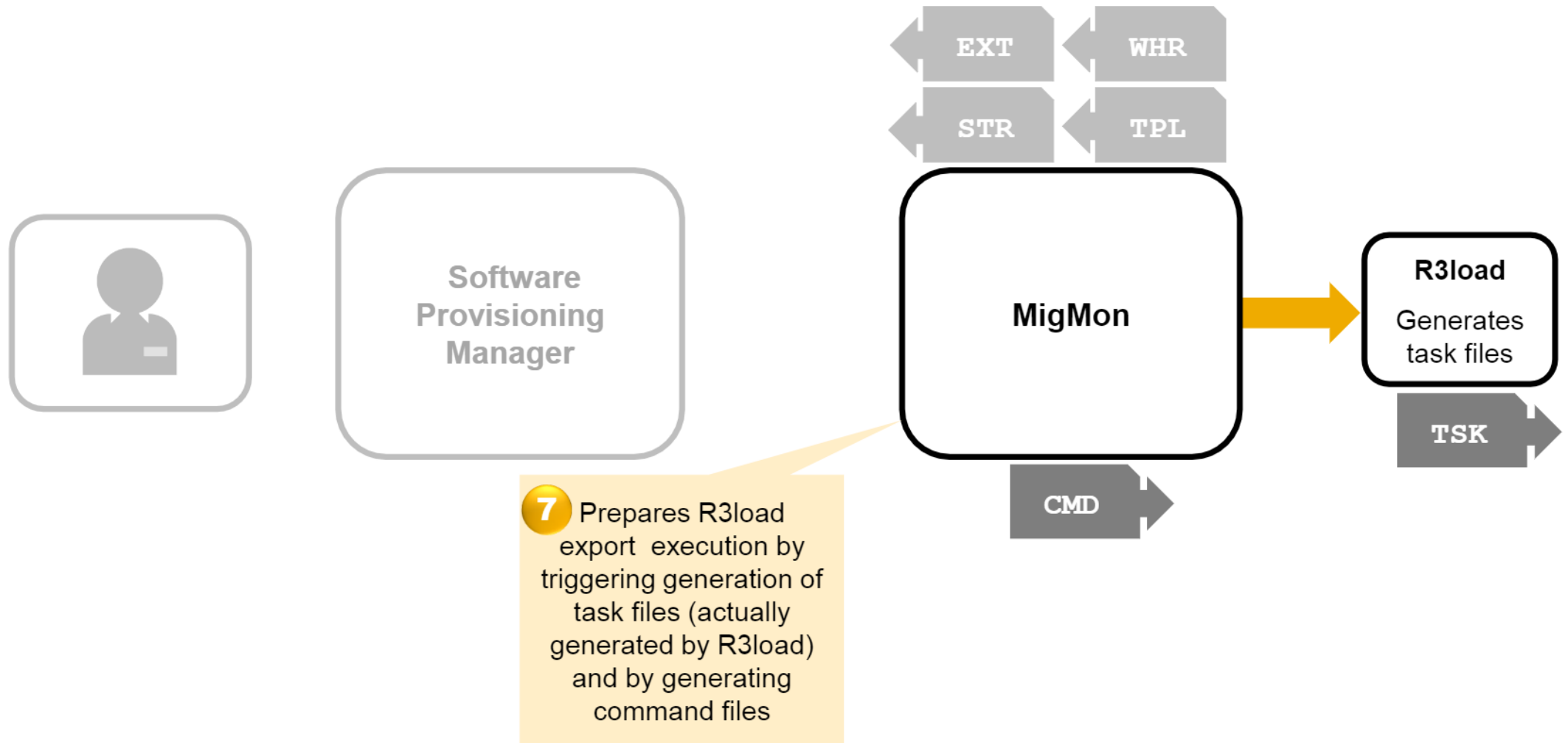

Migration of ABAP Systems

Process flow of export

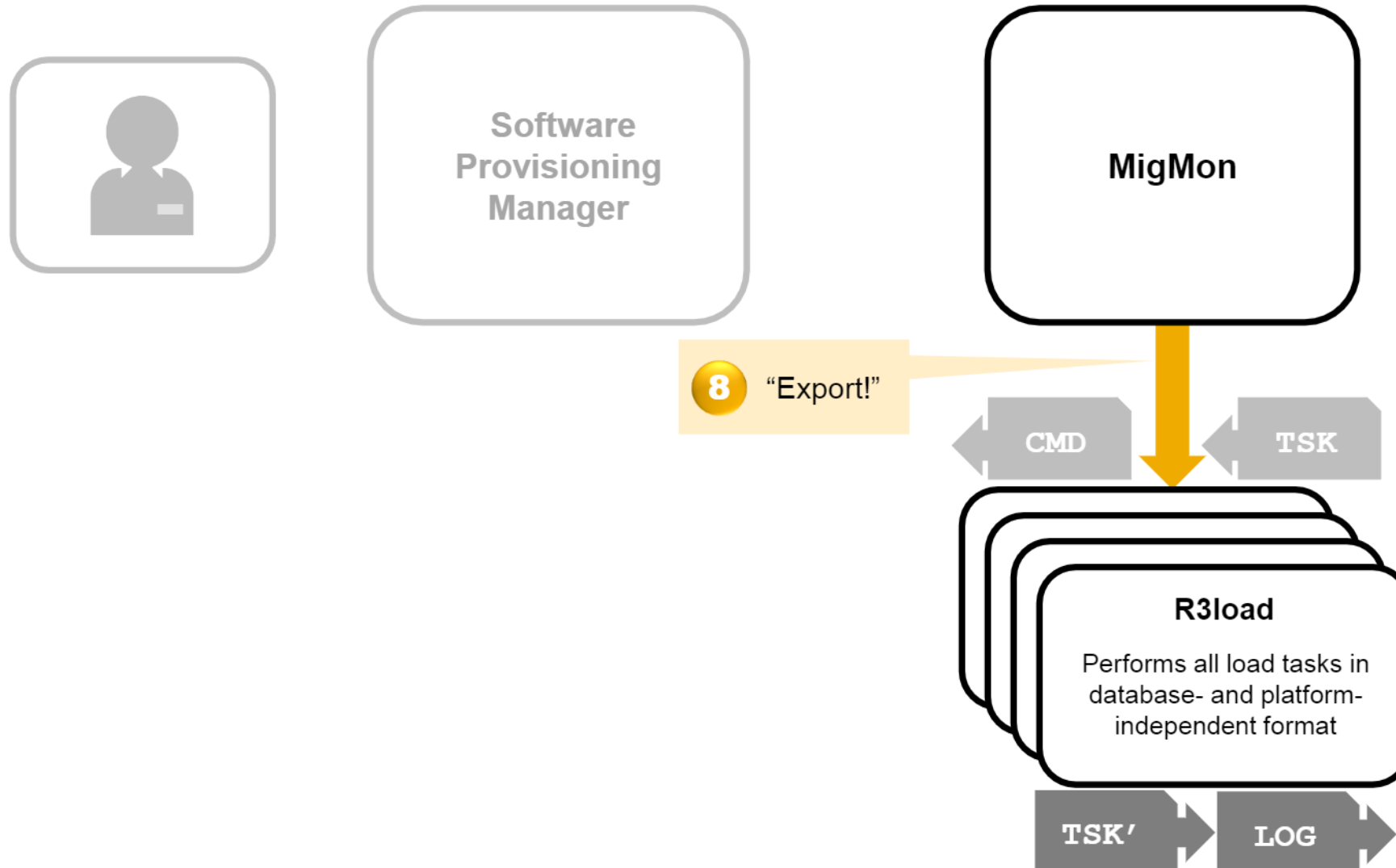

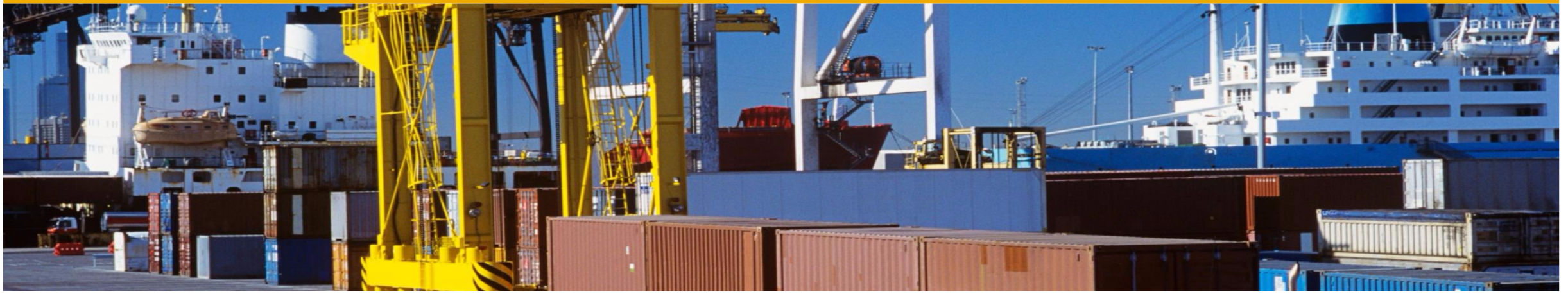

Heterogeneous ABAP System Copy

Standard process flow of import

Migration of ABAP Systems

Process flow of import



Migration of ABAP Systems

Process flow of import

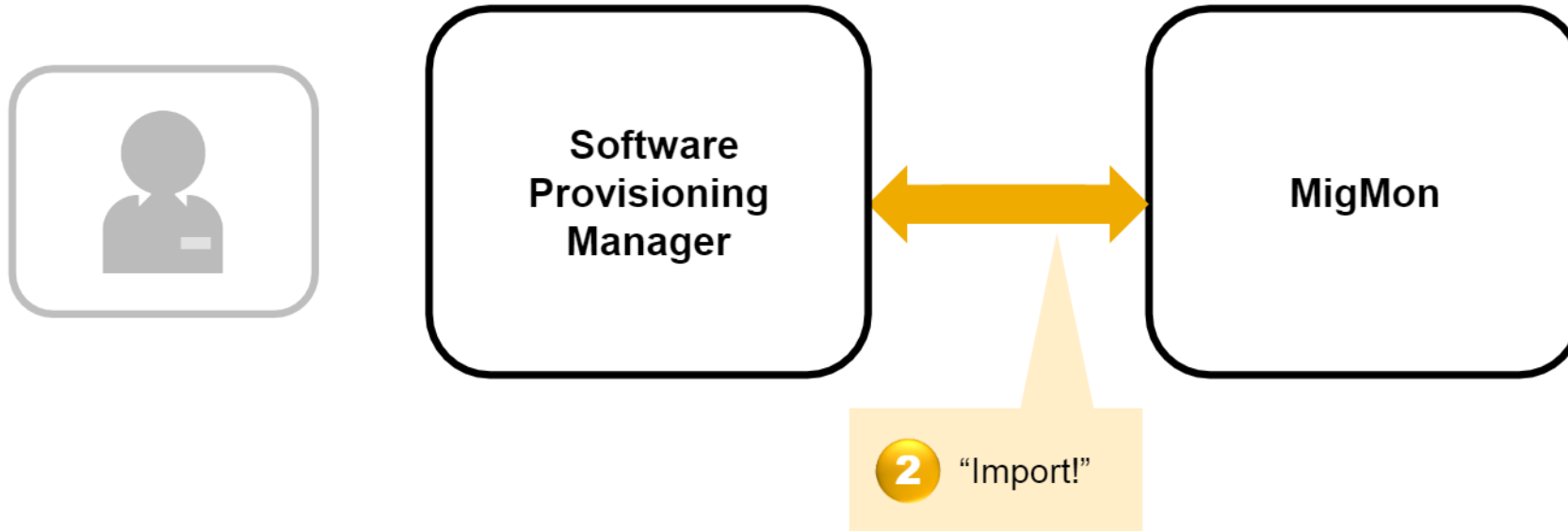

Migration of ABAP Systems

Process flow of import

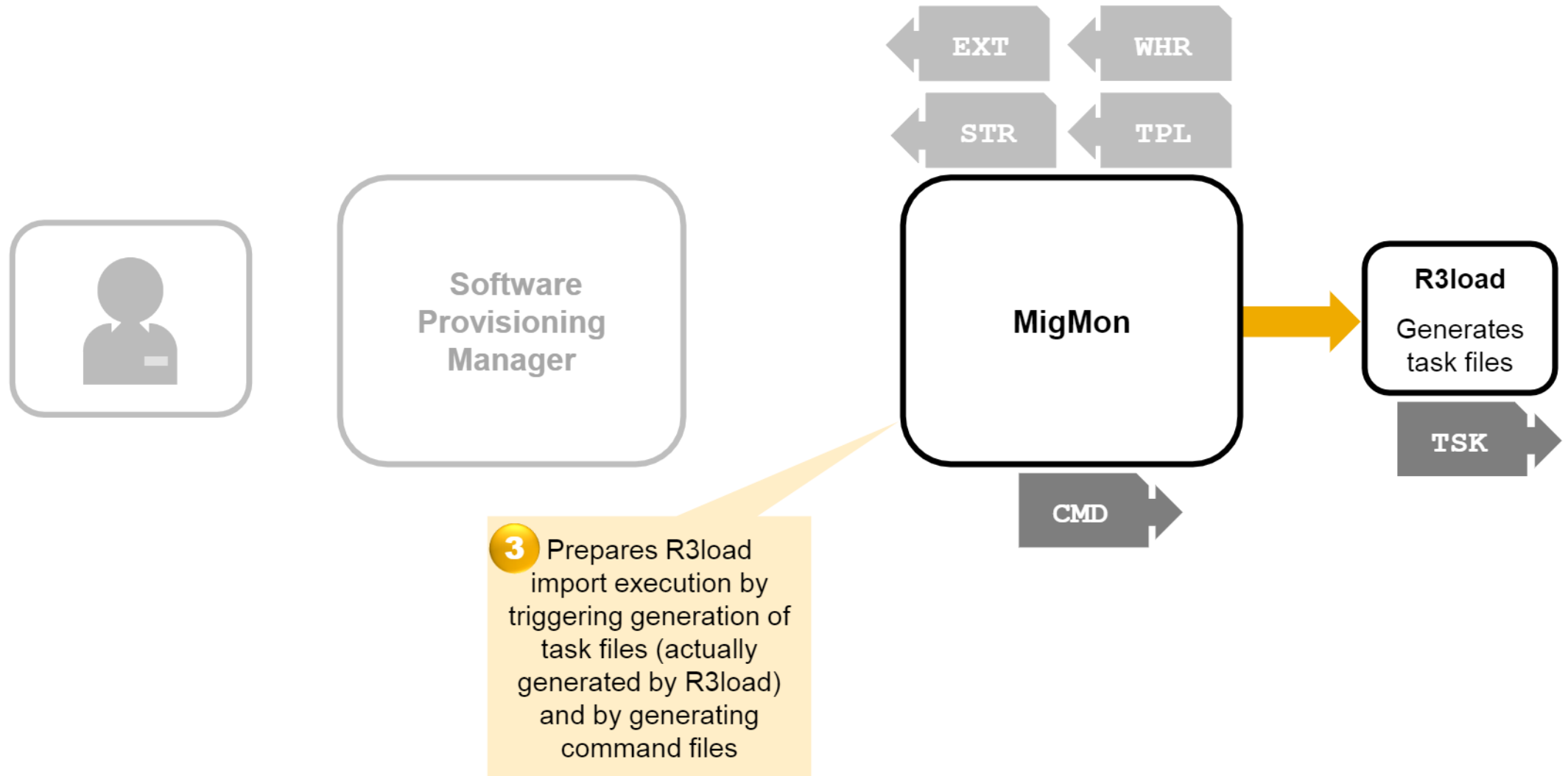

Migration of ABAP Systems

Process flow of import

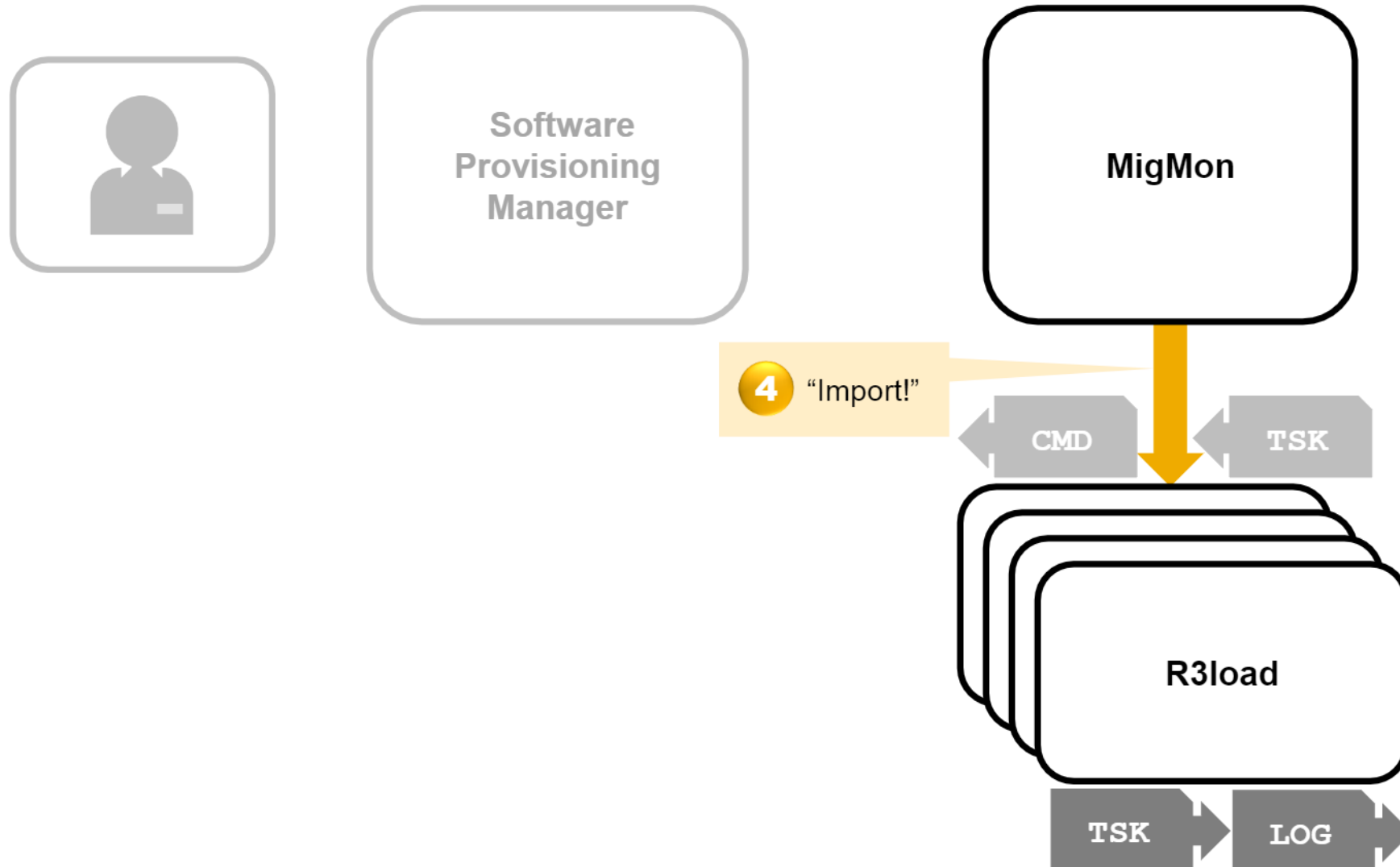

Migration of ABAP Systems

Process flow of import

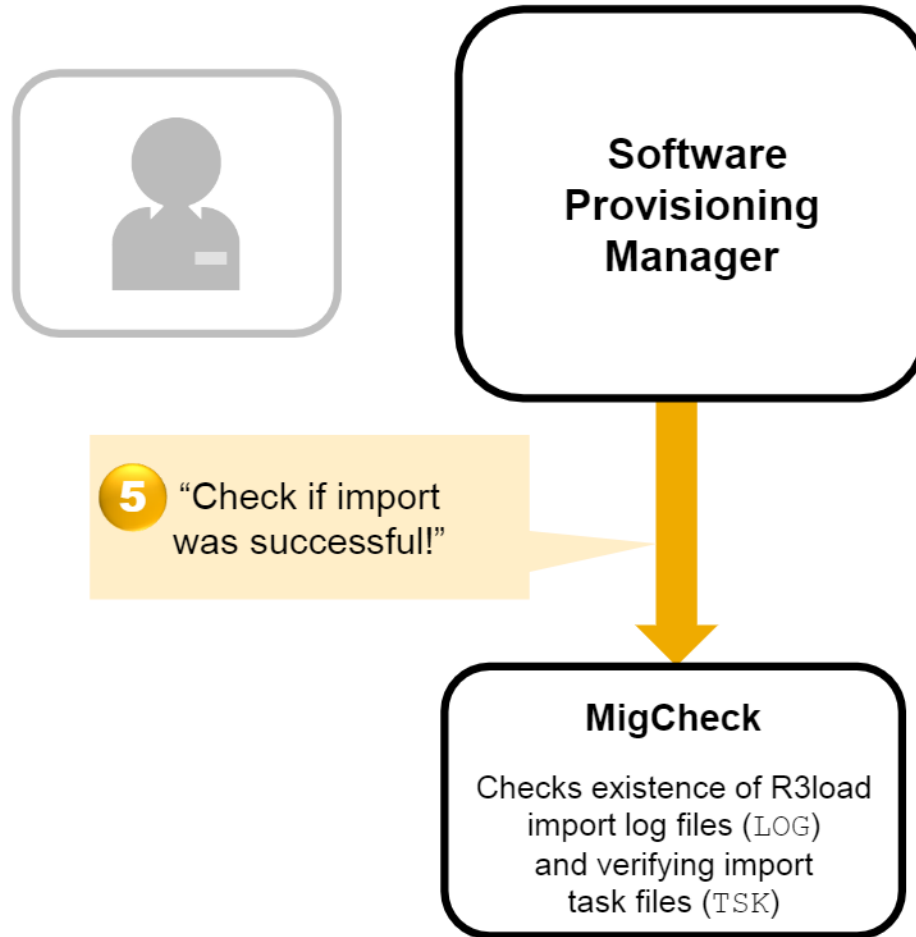

Migration of ABAP Systems

Process flow of import



Migration of ABAP Systems

Follow-up activities

Perform technical activities after migration procedure

- On source system
- On target system
- For more information, see system copy documentation

Perform post-migration tests

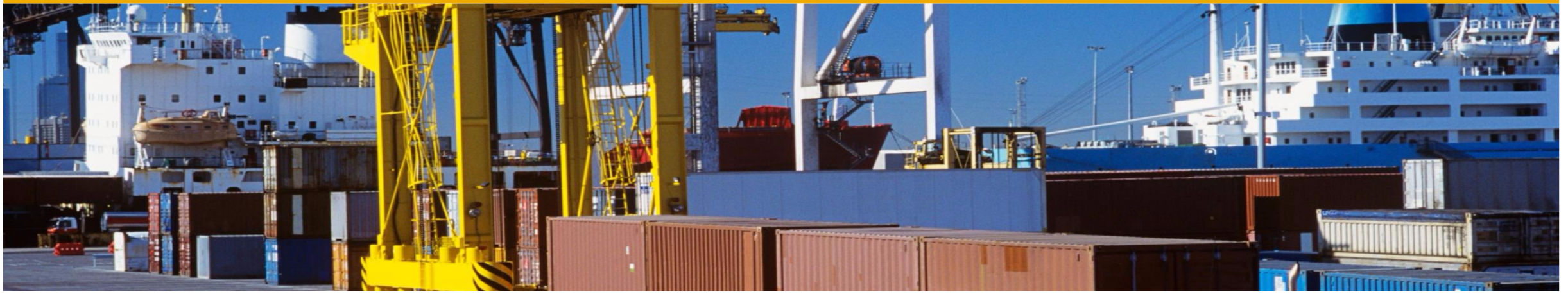

Further Information

Further Information

For more information, see:

- System copy guides available in SAP Service Marketplace at:

<http://service.sap.com/sltoolset>

→ *Software Logistics Toolset 1.0*

→ *Documentation*

→ *System Provisioning*

- System copy and migration page in [SAP Community Network](#)

SAP Idea Place

Influence the future of software logistics

- SAP Idea Place is your public channel to **participate in innovation** at SAP
- Enables you to **submit ideas, collaborate on and vote for ideas**, and connect with the teams that are responsible for software logistics procedures
- Complements traditional channels of interaction and feedback at SAP
- Contribute under <https://ideas.sap.com/softwarelogistics>

The screenshot shows the SAP Idea Place interface for the 'Software Logistics' category. The page has a blue header with a lightbulb icon and the text 'Software Logistics: Your channel for submitting ideas to improve Software Logistics'. Below the header, there is a 'Leaderboard' table, a 'Recent Ideas' list, and a 'Next Idea Review' date.

User	Points
Boris Zarske	108
Nicolas Butson	65
Berthier Nicolas	38
Bogdan Caradeica	35
Princey Albert Ath...	35
Jens Gleichmann	33
Karin Spiegel	27
Michele Cortinovis	26
Rajagopal Sampath	24
Dalbor Cip	23

Recent Ideas:

- Service pack level of initial installati...** (Submitted by Walter Mak... on 9/9/14 9:32pm, 2 votes)
- BI4.1 webi export to excel only** (Submitted by CYLEEZL CY on 8/25/14 12:56am, 2 votes)
- SUM MSCS Cluster release upgrade: Automa...** (Submitted by Thomas Koa... on 8/5/14 5:44am, 1 vote)
- Include copy and paste functions for shv...** (Submitted by Ivan Gonzo... on 8/4/14 4:34pm, 4 votes)
- HANA Statement Routing** (Submitted by Bogdan Car... on 7/31/14 12:02am, 3 votes)



Thank you

Contact information:

Boris Zarske – SAP Product Management
boris.zarske@sap.com

© 2015 SAP SE or an SAP affiliate company. All rights reserved.

No part of this publication may be reproduced or transmitted in any form or for any purpose without the express permission of SAP SE or an SAP affiliate company.

SAP and other SAP products and services mentioned herein as well as their respective logos are trademarks or registered trademarks of SAP SE (or an SAP affiliate company) in Germany and other countries. Please see <http://global12.sap.com/corporate-en/legal/copyright/index.epx> for additional trademark information and notices.

Some software products marketed by SAP SE and its distributors contain proprietary software components of other software vendors.

National product specifications may vary.

These materials are provided by SAP SE or an SAP affiliate company for informational purposes only, without representation or warranty of any kind, and SAP SE or its affiliated companies shall not be liable for errors or omissions with respect to the materials. The only warranties for SAP SE or SAP affiliate company products and services are those that are set forth in the express warranty statements accompanying such products and services, if any. Nothing herein should be construed as constituting an additional warranty.

In particular, SAP SE or its affiliated companies have no obligation to pursue any course of business outlined in this document or any related presentation, or to develop or release any functionality mentioned therein. This document, or any related presentation, and SAP SE's or its affiliated companies' strategy and possible future developments, products, and/or platform directions and functionality are all subject to change and may be changed by SAP SE or its affiliated companies at any time for any reason without notice. The information in this document is not a commitment, promise, or legal obligation to deliver any material, code, or functionality. All forward-looking statements are subject to various risks and uncertainties that could cause actual results to differ materially from expectations. Readers are cautioned not to place undue reliance on these forward-looking statements, which speak only as of their dates, and they should not be relied upon in making purchasing decisions.

© 2015 SAP SE oder ein SAP-Konzernunternehmen. Alle Rechte vorbehalten.

Weitergabe und Vervielfältigung dieser Publikation oder von Teilen daraus sind, zu welchem Zweck und in welcher Form auch immer, ohne die ausdrückliche schriftliche Genehmigung durch SAP SE oder ein SAP-Konzernunternehmen nicht gestattet.

SAP und andere in diesem Dokument erwähnte Produkte und Dienstleistungen von SAP sowie die dazugehörigen Logos sind Marken oder eingetragene Marken der SAP SE (oder von einem SAP-Konzernunternehmen) in Deutschland und verschiedenen anderen Ländern weltweit.

Weitere Hinweise und Informationen zum Markenrecht finden Sie unter <http://global.sap.com/corporate-de/legal/copyright/index.epx>.

Die von SAP SE oder deren Vertriebsfirmen angebotenen Softwareprodukte können Softwarekomponenten auch anderer Softwarehersteller enthalten.

Produkte können länderspezifische Unterschiede aufweisen.

Die vorliegenden Unterlagen werden von der SAP SE oder einem SAP-Konzernunternehmen bereitgestellt und dienen ausschließlich zu Informationszwecken.

Die SAP SE oder ihre Konzernunternehmen übernehmen keinerlei Haftung oder Gewährleistung für Fehler oder Unvollständigkeiten in dieser Publikation.

Die SAP SE oder ein SAP-Konzernunternehmen steht lediglich für Produkte und Dienstleistungen nach der Maßgabe ein, die in der Vereinbarung über die jeweiligen Produkte und Dienstleistungen ausdrücklich geregelt ist. Keine der hierin enthaltenen Informationen ist als zusätzliche Garantie zu interpretieren.

Insbesondere sind die SAP SE oder ihre Konzernunternehmen in keiner Weise verpflichtet, in dieser Publikation oder einer zugehörigen Präsentation dargestellte Geschäftsabläufe zu verfolgen oder hierin wiedergegebene Funktionen zu entwickeln oder zu veröffentlichen. Diese Publikation oder eine zugehörige Präsentation, die Strategie und etwaige künftige Entwicklungen, Produkte und/oder Plattformen der SAP SE oder ihrer Konzernunternehmen können von der SAP SE oder ihren Konzernunternehmen jederzeit und ohne Angabe von Gründen unangekündigt geändert werden.

Die in dieser Publikation enthaltenen Informationen stellen keine Zusage, kein Versprechen und keine rechtliche Verpflichtung zur Lieferung von Material, Code oder Funktionen dar. Sämtliche vorausschauenden Aussagen unterliegen unterschiedlichen Risiken und Unsicherheiten, durch die die tatsächlichen Ergebnisse von den Erwartungen abweichen können. Die vorausschauenden Aussagen geben die Sicht zu dem Zeitpunkt wieder, zu dem sie getätigt wurden. Dem Leser wird empfohlen, diesen Aussagen kein übertriebenes Vertrauen zu schenken und sich bei Kaufentscheidungen nicht auf sie zu stützen.